



**OPORTO
MAISON**
ENTREPREDES

INFORMATION BOOK

Oporto Maison Entreparedes

PORTO DORME SERVIÇOS HOTELEIROS, LDA.

WELCOME LETTER

Dear guest,

Welcome to the beautiful city of Porto and thank you for choosing **Oporto Maison Entreparedes** for your stay.

Our team will do their best to make your stay unforgettable. We will be pleased to give you all the information necessary, and we share with you some important points to keep in mind during your stay:

- Reception Hours: 9am – 6pm
- Emergency Telephone Number: + 351 911 928 244
- Cleaning Service: cleaning is done day-in, day-out, unless you request at the reception desk for daily cleaning.

Thank you for your preference.

Oporto Maison Entreparedes Team

<https://www.oportomaison.com/oporto-entreparedes/>

Rua de Entreparedes, 7

4000-198 Porto

INDEX

A. IMPORTANT INFORMATION	4
B. OUR RESPONSIBLE TOURISM POLICY	5
C. THE OPERATION OF HOUSEHOLD APPLIANCES	6
D. WASTE COLLECTION AND RECYCLING	6
E. GET TO KNOW THE REGION'S TOURIST OFFER	8
1. GASTRONOMIC EXPERIENCE (catering establishments)	8
• Restaurants, Cafés, and Bars in Porto	8
Traditional	8
Francesinha Sandwich – Porto Specialty	8
Tascas - Snacks	9
Vegetarians	9
Other Options	9
2. FADO	9
3. NIGHTLIFE	9
... into the Night ...	9
4. HERITAGE / CULTURAL OFFER	10
• To visit in PORTO	10
• To visit in the Region	12
5. WHAT TO DO?	13
• Tours in the region	13
• Sun and Sea (Porto and surroundings)	13
• Walking Tours	14
• Viewpoints	14
• Birdwatching	14
F. BECAUSE YOUR OPINION IS IMPORTANT, SHARE YOUR EXPERIENCE WITH US	14

A. IMPORTANT INFORMATION

Emergency

In an emergency (ambulance, police, fire), call **112** immediately.

Indicate your location: Rua de Entreparedes, 7 - Porto.

In case of fire: Fire extinguishers are located on the floors. Leave the room as soon as possible. After calling 112, call **+351 911 928 244**.

Medical Emergency

Contact the SNS - available 24h/7 - Telephone: **808 242 424**.

Arrival and Departures

Check-in time: from 3.30 pm.

Check-out time: until 11 am.

Common Area

No additional persons are allowed in the rooms beyond what is booked.

No pets are allowed in the flats, with **the exception of assistance animals**.

Parties are not allowed.

You should avoid making noise in the common areas and outdoor spaces after 10 pm.

Breakfast

Breakfast, when included in your rate, will be delivered at your apartment.

Wi-Fi

Internet service is provided for your enjoyment. We advise responsible, safe, and appropriate use, in compliance with all laws in force. If there is any service failure, please contact us.

Border Services

All short-term accommodation in Portugal is required to report the presence and identity of guests to AIMA - Portugues Agency for Integration, Migration and Asylum.

B. OUR RESPONSIBLE TOURISM POLICY



RESPONSIBLE TOURISM POLICY

Oporto Maison faces the good practices of sustainability, not as an obligation, but as a natural way of being.

Aware of the importance of maintaining a sustainable tourism development and assuming the principles adopted specifically in the World Charter for Sustainable Tourism, the **Oporto Maison** is committed to carry out a sustainable management of its activities, as well as comply with the requirements established in the Biosphere Sustainable, which includes, among other things, the legal requirements that regulate the effects generated by tourism activity. Therefore, we base all our policies and values in this sense, and we commit to:

- Motivate and train our employees with training and awareness-raising activities on the principles of Responsible Tourism.
- Promote good environmental practices.
- Participate in external activities and to inform both internally and externally about the company's environmental advances and actions.
- To fight against sexual exploitation, or any other form of exploitation and commercial harassment of children, adolescents, women, and minorities.
- Include the commitment to adopt accessibility measures for people with disabilities (sensory, physical, intellectual, and mental).

One of our main goals is to improve sustainable management, undertaking commitments for continuous improvement in all areas of sustainability: social, economic, and environmental, as well as customer satisfaction. To this end, future projects will consider sustainability criteria and the efficient use of resources.

Cofinanciado por:



Aware of the importance of maintaining a sustainable tourism development and assuming the principles specifically adopted in the World Charter for Sustainable Tourism, the **Oporto Maison** is committed to carrying out a sustainable management of its activities, as well as complying with the requirements established in the Biosphere Sustainable standards, which includes, among other things, the legal requirements that regulate the effects generated by tourist activity.

C. THE OPERATION OF HOUSEHOLD APPLIANCES

Note: The electric current in Portugal is 220V. The tap water is drinkable and of excellent quality.

Household Appliance	Instructions
Fridge	It is always on at a minimum temperature.
Exhaust	Turns on and off by opening and closing the tray.
Microwave + grill	Press the start button.
Cooktop	Please check the specific manual at the end of this document.
Electric kettle	It must be plugged in, add water, and press the lever to start. The kettle switches off automatically once the water reaches the set temperature.
Air conditioner	It must be started or stopped by pressing the ON/OFF key. Then select the desired temperature by pressing the \triangle or ∇ Adjust the speed by pressing the FAN button. The air conditioning mode is pre-set for the time of the year, so for proper operation of the appliance we advise you not to change the mode.
Television	To switch on you must use the remote control on the POWER button.

D. WASTE COLLECTION AND RECYCLING

Collaborate with us! Help us to separate and recycle your rubbish!

In **Oporto Maison Entreparedes** we contribute to the fulfilment of the 3 R's Policy (Reduce, Reuse and Recycle). This is an incentive, in the sense of influencing our clients, to pollute less the environment through a conscious consumption and through a sustainable management of the products and materials used in our daily life. With these three main steps, we will have a more preserved environment, because the generation of waste by society will be lower. Of course, this is not the only measure to preserve nature, but it is certainly an important step to ensure a better world for future generations.

Fight against waste

Oporto Maison Entreparedes, aware of the consequences of an inordinate use of resources, seeks to make an efficient management of them, in favour of the sustainable development.

Waste disposal and recycling

At the **Oporto Maison Entreparedes** we proceed to the separation of the following waste:

- Paper / Plastic / Glass - separation and deposit in the “Eco Point”.
- Batteries.

Conscious Waste Separation

At your arrival you will find 3 coloured bags (blue, yellow, and green) in the flat, an invitation to separate waste for correct disposal.

Sustainability and Social Responsibility

In **Oporto Maison Entreparedes** we carry out actions together with the community such as donation of furniture and bed and bath linen, support to local artists, internships for professional training of students in the labour market.

Resource Management Efficiency

Aware of the importance of efficiency in resource management, we have been implementing a set of practices:

- Lighting with natural light - Without compromising the building's thermal behaviour requirements, we have tried to ensure that natural lighting is predominant in all the building' spaces.
- Environmentally friendly lighting - The interior lighting was entirely designed with led lamps and timer as a measure to promote energy efficiency.

Additionally, a set of good practices are promoted daily and disseminated throughout the organisation with the same objective:

- Internal campaign to raise awareness of separation and recycling.
- Collection of used batteries.
- Guidelines for printing documents.
- Internal campaign for the adoption of environmentally friendly practices.

E. GET TO KNOW THE REGION'S TOURIST OFFER

1. GASTRONOMIC EXPERIENCE (catering establishments)

Note: non-exhaustive information for restaurants. In addition, consult opening hours directly with each establishment.

- Restaurants, Cafés, and Bars in Porto

Traditional

Name	Location	Contact
Abadia	R. do Ateneu Comercial do Porto 22	+ 351 222 008 757
Postigo do Carvão	R. da Fonte Taurina 24	+ 351 222 004 539
Restaurante Caetano	Av. Fernão de Magalhães 1194	+ 351 225 369 350
Maria Rita	Rua da Alegria 16	+ 351 222 050 693
Casa Nanda	Rua da Alegria 394	+ 351 225 370 575
Casa Viúva	Rua Actor João Guedes 15	+ 351 222 000 672
Senhor Zé	Rua do Campinho 13	+ 351 222 051 011
A Cozinha do Manel	Rua do Heroísmo 215	+ 351 225 363 388
Yuko	Rua de Costa Cabral 2331	+ 351 225 482 291
Vaccarum	Rua de Fernandes Tomás 839	+ 351 221 127 181
Euskalduna Studio	Rua de Santo Ildefonso 404	+ 351 935 335 301

Francesinha Sandwich – Porto Specialty

Name	Location	Contact
Cervejaria Brasão	Rua de Passos Manuel 205	+ 351 931 989 364
Café Santiago	Rua de Passos Manuel 226	+ 351 222 055 797
Lado B	Rua de Passos Manuel 190	+ 351 222 014 269

Tascas - Snacks

Name	Location	Contact
Xico dos Presuntos	Rua do Heroísmo 191	+ 351 225 370 514
Nabos na Púcara	Rua da Picaria 40	
Casa Guedes	Praça dos Poveiros 130	+ 351 222 002 874
Tapa Bento	R. da Madeira 222	+ 351 912 881 272

Vegetarians

Name	Location	Contact
O Macrobiótico	Rua do Bonfim 63	+ 351 964 246 130
Essência	Rua de Pedro Hispano 1190	+ 351 228 301 813
DaTerra Baixa	Rua Mouzinho da Silveira 249	+ 351 223 199 257

Other Options

Name	Specialty	Location	Contact
Shiko	Japanese Snacks	Rua do Sol 238	+ 351 223 239 671
Boa Bao	Pan Asiático Restaurant	Rua da Picaria 61	+ 351 910 043 030
Ostras & Coisas	Seafood	Rua da Fábrica 73	+ 351 918 854 709
O Tubarão	Seafood, Fish	Rua do Sul 65	+ 351 911 060 939

2. FADO

Name	Location	Contact
Casa da Mariquinhas	Rua de São Sebastião 25	+351 915 613 877

3. NIGHTLIFE

... into the Night ...

Name	Activities	Location	Contact
Maus Hábitos	Club	Rua de Passos Manuel 178 4º Piso	+ 351 937 202 918
Hot Five	Jazz & Blues Club	Rua Guerra Junqueiro 495	+ 351 934 640 732

4. HERITAGE / CULTURAL OFFER

Note: non-exhaustive information for cultural offer. Please consult additional opening hours and other information on the individual pages of each facility.

TOURISM OFFICE – From 9 am to 7pm	Loja Interativa Porto - <i>Welcome Center</i> Praça de Almeida Garrett 27 4000-069 Porto + 351 927 411 817
--------------------------------------	---

- To visit in PORTO

1- Ponte Luís I	 <p><i>Fonte: TripAdvisor</i></p>
<p>Luís I Bridge is a metal structure bridge with two decks, built between the years 1881 and 1888, connecting the cities of Porto and Vila Nova de Gaia separated by the river Douro in Portugal.</p>	
Location	Porto
GPS Co-ordinate	41° 8' 23" N, 8° 36' 34" W

2 – Cais da Ribeira	 <p><i>Fonte: TripAdvisor</i></p>
<p>Located in the historic centre of Porto, Praça da Ribeira, next to the pier with the same name, is one of the oldest squares in the city, already mentioned in royal charters in 1389, although with a different layout from today. It was in this area of Ribeira and in its commercial connection with the River Douro that the city began its development and turned towards the river. At the “Cais”, it is possible to see a door called the Postigo do Carvão (Coal Wicket), belonging to the Fernandina Wall, built in the 14th century, the only example that has survived to the present day. The narrow and winding streets, overlooking Gaia, the shady arcades, typical houses with colourful façades from other times, its urban-rural architecture, surrounded by cafés and shops make this one of the main tourist areas of the city</p>	
Location	Porto
GPS Co-ordinate	41°08'26.5"N 8°36'42.8"W

3 – Palácio da Bolsa	 <p style="text-align: right;"><i>Fonte: TripAdvisor</i></p>
<p>A national monument, located in the historic centre of the city of Porto, classified as World Heritage by UNESCO, the Stock Exchange Palace, built by the Porto Trade Association on the ruins of the S. Francisco Convent, became Porto's visiting room par excellence, receiving the most illustrious visitors, including monarchs, presidents, and ministers from almost every country, making this building the most visited monument in the north of the country.</p>	
Location	Rua de Ferreira Borges, 4050-253 Porto
Contact	+351 223 399 000
GPS Co-ordinate	41° 8' 29" N 8° 36' 55" O 41° 8' 29" N 8° 36' 55" O

4 – Torre dos Clérigos	 <p style="text-align: right;"><i>Fonte: TripAdvisor</i></p>
<p>The Clérigos Tower is the Porto's ex-libris. It opened its doors in 1763, becoming the tallest belfry in Portugal, with more than 75 meters. In 1753, the Italian architect Nicolau Nasoni was invited to design and build this magnificent heritage, considered a National Monument since 1910. The famous church was built in the 18th century, between 1732 and 1749, and this was the most emblematic work of the architect Nicolau Nasoni. It is one of the most beautiful baroque temples, and a reference in the history of Porto.</p>	
Location	Rua de São Filipe de Nery, 4050-546 Porto
Contact	+351 220 145 489 info@torredosclerigos.pt
GPS Co-ordinate	N 41° 8' 47.3166", W 8° 36' 52.254"

<p>5 – Livraria Lello</p>	 <p style="text-align: right;"><i>Source: livrarialello.pt</i></p>
<p>The Livraria Lello building is one of the most emblematic of the neo-Gothic style in the city of Porto and in Portugal, standing out in the surrounding urban landscape. Since 1906 it carries with it more than a century of history and stories, embedded in the architectural space and in the bookseller's knowledge that shape the experience of those who visit and those who read it</p>	
<p>Location</p>	<p>Rua das Carmelitas 144</p>
<p>Contact</p>	<p>customercare@livrarialello.pt</p>
<p>GPS Co-ordinate</p>	<p>N 41 08.796' W 008 36.882' (41.14660, -8.61470)</p>

- To visit in the Region

<p>1- Alto Douro Vinhateiro – Cultural Heritage</p>	 <p style="text-align: right;"><i>Source: patrimoniocultural.gov.pt</i></p>
<p>The Alto Douro Wine Region is a particularly representative area of the landscape that characterises the vast Demarcated Douro Region, the oldest regulated wine region in the world. The cultural landscape of the Alto Douro combines the monumental nature of the Douro River valley, made up of steep slopes and poor, rugged soils, with the ancestral and continuous action of Man, adapting the space to the agricultural needs of the Mediterranean type that the region supports. This relationship between human activity and nature has created an ecosystem of unique value, where the characteristics of the land are put to exemplary use by shaping the landscape in terraces, preserving it from erosion and allowing vines to be grown. The region produces the famous Port wine, representing the main vector of dynamization of the local technology, culture, traditions and economy.</p>	
<p>Location</p>	<p>Douro Region; Trás-os-Montes and Alto Douro Region</p>

5. WHAT TO DO?

Note: non-exhaustive information. For further information and opening hours, please contact the responsible organisms.

- Tours in the region

Douro River	6 Bridges Cruise One of the best ways to discover the city of Porto is on board a cruise. We propose a 50-minutes boat ride along the stunning shores of Porto and Vila Nova de Gaia
Port Wine	Port Wine Cellars The Port Wine Cellars are a Portuguese ex-libris and document an unusual history of temperance and boldness. Open for visits all year round, to visit them is to deepen your knowledge about Port Wine, the Douro region and the cities of Porto and V.N. de Gaia.

- Sun and Sea (Porto and surroundings)

Name	Features
Praia do Homem do Leme	Going to Foz is a must for anyone visiting Porto. And so is extending your towel at Praia do Homem do Leme. Like all the beaches in the area, it has a blue flag, and the rocks are part of the scenery. For the little ones, there's a children's playground, right in front of the beach; for the grown-ups, there are two bars with everything you could want in the summer: lupins, beers, and mojitos.
Praia da Madalena	With a long stretch of sand that invites you to relax or stroll along the seafront, Madalena beach is one of the most popular in Gaia. If you always carry a pair of trainers in your car bag, put them on and walk along the wooden walkway.
Praia da Memória	It's one of the best in the area to take the kids. But only in the morning. In the afternoon it's quiet, with no running around or water pistols. It has lifeguard surveillance, tents for rent, a bar right on the sand and a historical side that is also important to underline: the Obelisk of Memory was built to remember the Disembarkation of Mindelo, in 1832. The first stone was laid on December 1 st , 1840, but the obelisk was only completed 24 years later.

- Walking Tours

Free Walking Tours	<p>Experience Porto as an authentic local. Choose between the Classic Tour (10.45am) and the Lifestyles of Porto (3.30pm).</p> <p>Meeting Point: Praça da Liberdade Next to Pedro IV Statue</p> <p>Information: portowalkers.pt</p> <p>Reservations: +351 932 613 890</p> <p>Email: booking@portowalkers.pt</p>
---------------------------	---

- Viewpoints

Miradouro das Fontainhas	R. de Gomes Freire 18
Elevador da Lada Ribeira	Rua da Lada
Miradouro da Bateria da Vitória	Rua de São Bento da Vitória 11

- Birdwatching

Douro Estuary Local Nature Reserve	<p>Further Information: https://www.parquebiologico.pt/reserva-natural-local-do-estuario-do-douro</p>
---	--

F. BECAUSE YOUR OPINION IS IMPORTANT, SHARE YOUR EXPERIENCE WITH US

Please review us on TripAdvisor, Booking or Google, and/or send your suggestions to: entreparedes@oportomaison.com

HOW TO USE THE COOKTOP

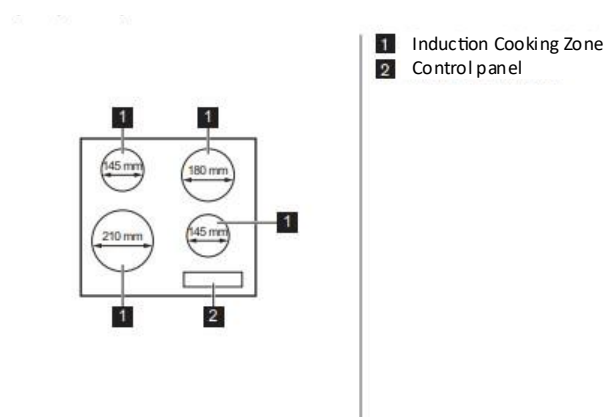

Control panel layout

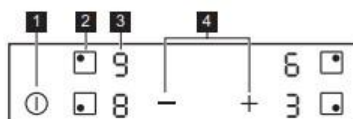

Use the sensor fields to control the device. The displays, indicators and sounds indicate which functions are in operation

	Campo do sensor	Função	Comentário
1	ⓘ	ON/OFF	To activate and deactivate the cooktop
2	■	-	To select the cooking zone
3	-	Cooking level indicator	To indicate the cooking degree
4	+ / -	-	To adjust the cooking degree

**Help us to reduce water and energy
consumption and be more sustainable**



Turn off the lights



Turn off the tap when not in use



**Do not leave appliances on
stand-by**



Turn off the air conditioning